

CERAMIC. GRAPHITE. HEAT EXCHANGERS. PROCESS EQUIPMENT

INCREASE YOUR PLANT PRODUCTIVITY

LESS DOWNTIME. LOWER MAINTENANCE

MANUFACTURED BY
CG Thermal
PROCESS EQUIPMENT

PHONE 330-787-9101
FAX 330-787-2304

PROCESS	SERVICE
100/FV	100/FV
340	340
130	130

DRAWING NO. H12-0104
YEAR 2012

ASME CODE CONSTRUCTED & CODE STAMPED
PER ASME 2010 SECTION VIII, DIVISION 1, 2011

- UNLESS OTHERWISE SPECIFIED
- 1 BREAK ALL SHARP CORNERS
 - 2 ALL 2 PLC. DIM +/- .015
 - 3 ALL 3 PLC. DIM +/- .005
 - 4 ALL FRACTIONAL DIM +/- 1/8
 - 5 ALL DIM IN ENGLISH MEASURE

CG Thermal

8950 Dutton Drive
Columbus, OH 43240

PROCESS

MODEL HP
UMA

MATERIO

HIGH TECHNOLOGY PRODUCTS AND SERVICES FOR YOUR MOST DEMANDING CORROSIVE CHEMICAL ENVIRONMENTS

CG Thermal fully understands the specialized needs of the markets and customers that we serve, many of whom demand custom-designed heat exchangers to meet very specific process and/or plant conditions. We have available within our capabilities extensive thermal and mechanical design resources which we apply to our customers' needs. Our design team, with an aggregated experience of over 125 years, includes mechanical and chemical engineers with considerable expertise in specialized heat transfer systems and design. We use state-of-the-art design software to help create and fabricate custom designed units which meet your project requirements better than standard off-the-shelf and competitor models.

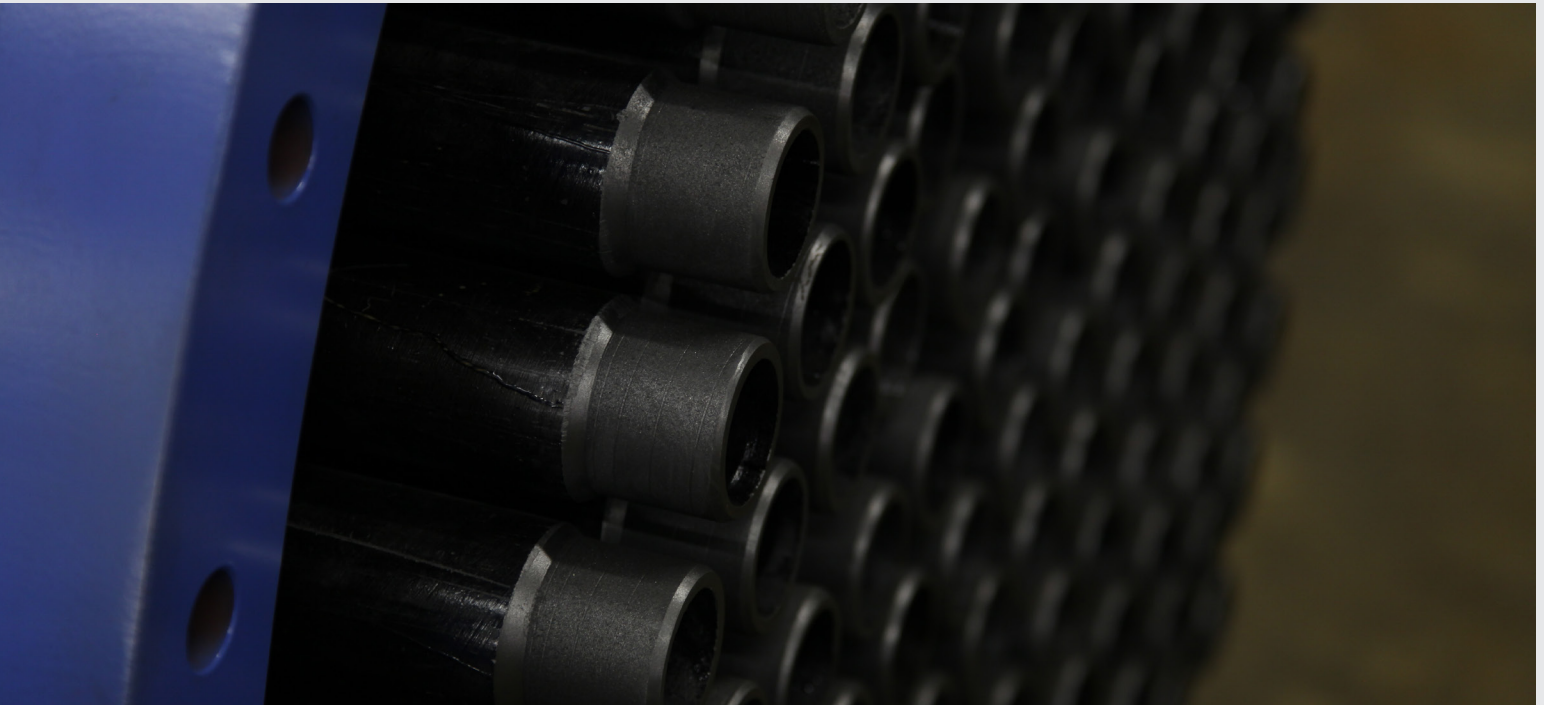

PRODUCTS AND CAPABILITIES

CG Thermal is a full service, graphite and ceramic heat exchanger manufacturer. All of the critical processes, from initial mechanical and thermal design to graphite impregnation are done in-house. CG Thermal has well established, proven and stringent material and design standards based on best industry practice and over 50 years of combined application history.

Our products are specifically designed and manufactured for service in the chemical process industry's most demanding corrosive processes. We especially find application in processes involving either highly oxidizing and reducing acids or halogens, or in processes where contamination from metallic process equipment is of concern. The proprietary materials we use have been developed and continuously improved to outperform and offer higher value than competitive metallic and non-metallic material options.

Impervite® graphite the big advantage

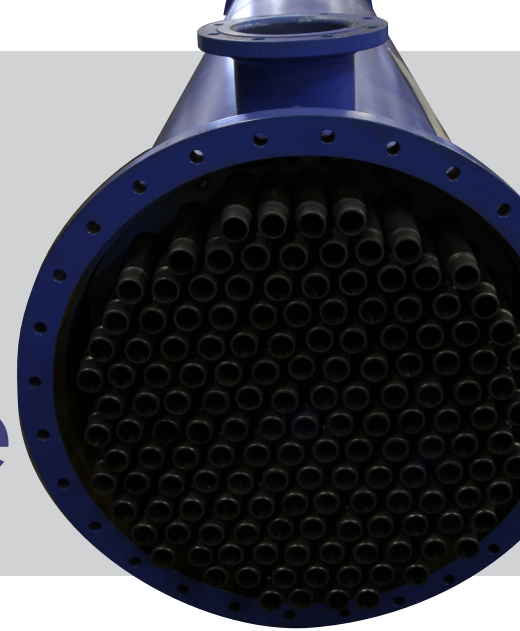

Impervite® brand impervious graphite is a composite material consisting of a graphite base material impregnated with a proprietary phenolic resin using a well-controlled process. Impervite® impervious graphite heat exchangers are ideally suited for processes involving the heating or cooling, condensing, and evaporating of sulfuric acid, hydrochloric acid, phosphoric acid, nitric acid, mixed acids, chlorinated hydrocarbons and many other highly corrosive fluids.

The base graphite is selected for optimum physical properties to maximize penetration depth of our phenolic resin impregnation, resulting in optimum Impervite® properties. When choosing raw graphite, the critical properties we consider are grain size, grain distribution, percent of voids, strength and thermal conductivity. All of these properties are important to ensure a final product that meets our high expectations and quality standards.

It is interesting to note that carbon and graphite are produced using the same process - the difference is that the carbonization process is terminated at about 840°C (1550°F) where graphitizing requires typical temperatures in excess of 2600°C (4600°F). Since they are different phases of the same material, the physical and thermal properties of carbon and graphite are different: carbon has higher initial strength properties but is more of an insulator and is less tough; graphite is less brittle and has higher thermal conductivity. CG Thermal supplies fully graphitized tubes which are the industry leader in regards to thermal shock resistance and fatigue life.

	IMPERVITE®	Brand M
CONDUCTIVITY (W/Mk)	100	64
TENSILE STRENGTH (Mpa)	28	29
CTE (x 10-6/C)	1.88	3.1
YOUNG'S MODULUS (Gpa) (-10)	158	150
THERMAL SHOCK RESISTANCE	9	4

1. Thermal Shock resistance = $\frac{\text{Conductivity} * \text{Tensile Strength}}{\text{CTE} * \text{Young's modulus}}$

2. "Brand M" properties are from published values.

The resin specified by CG Thermal to produce Impervite® has properties that are field-proven to match specifically with the base graphite properties and our impregnation process. This resin consists of a phenolic compound, solvent and carrying fluids. The viscosity and miscibility of the resin are controlled to insure a consistent and reliable impregnation process.

Impervite® is produced using a four step impregnation process that, depending upon the geometry of the graphite being treated, can be repetitive:

1. The graphite is heated to drive off moisture and contamination.
2. The graphite is subjected to a high vacuum to remove air from the voids then flood them with the resin
3. The tank is then subjected to high pressure to force the resin into the voids, maximizing graphite penetration depth.
4. The resin in the graphite is polymerized to the desired hardness using controlled heating.

The rate of polymerization is closely controlled and monitored because if the process is performed too quickly or too slowly the graphite will not be fully impregnated, and porosity or micro-cracks can result. Impregnation records are filed as a quality assurance policy.

By carefully measuring the resin properties and matching the characteristics of the graphite, we can guarantee a final product that consistently meets our mechanical, thermal and corrosion resistant standards. Impervite® graphite heat exchangers meet or exceed all other phenolic impregnated graphite in thermal conductivity, thermal efficiency and corrosion resistance.

In those rare cases of corrosive applications where either the impregnation resin and/or the graphite base is questionable in regards to corrosion resistance our Umax® Advanced Ceramic heat exchanger is the ideal solution, offering features and benefits not found in any other heat exchanger. *Details can be found on page 7 of this bulletin.*



Impervite® shell & tube heat exchangers

Product Overview

CG Thermal's Impervite® shell and tube exchanger design is the "work horse" of the industry. Utilizing our proprietary grade of phenolic impregnated graphite it offers excellent service life in corrosive condensing, vaporizing, absorbing, heating and cooling applications. Compared to other graphite heat exchanger designs it has competitive capital investment cost, high reliability, and high return on investment.

Key Points

- Excellent fatigue resistance
- High thermal shock resistance
- Long life



Scan QR Code with your mobile device for **Tech Specs**

Standard and custom designed units are available in both 7/8" (22mm) and 1.50" (38mm) inside diameter tubing. Our thermal design engineers will precisely size the optimum unit to meet your process specifications. Heat transfer areas range from 12.0 ft² (1.12m²) to 14,678 ft² (1471 m²). CG Thermal shell and tube exchangers have large cross sectional flow areas relative to competing graphite heat exchanger designs, making them well suited for high fouling applications or when the allowable process pressure drop requirements are low. Typical applications include condensers, vaporizers, absorbers, coolers and heaters. All CG Thermal shell and tube products are manufactured using Impervite® fully graphitized tubing. The high thermal conductivity and coefficient of thermal expansion increases the tube resistance to thermal shock and increases its thermal efficiency.

Features & Benefits

- Every unit tested to meet ASME code requirements and demanding in-house standards
- Exclusive skirted floating tube sheet design eliminates harmful tensile loading on the tube sheet and allows for full ASME code stamp by containing all the graphite within metal
- Flat-plate graphite nozzle design that eliminates the grooves and stress loads on the graphite nozzles which can lead to failure/cracking
- Shell material options and various corrosion resistant coatings are available upon request
- Phenolic resin impregnation
- ASME part UIG G mark units available
- Complete flow vibration analysis performed on all new units to ensure the lowest operating stresses within the unit due to fluid flow
- FRP, Teflon or metal baffles utilized in place of the graphite baffles supplied by others - graphite baffles are prone to breakage and make tube replacement more difficult
- Single-piece non-segmented tube sheets
- Standard operating limits to up to 100 psig (6.89 barg) and 340°F (171°C). Higher pressure limits available.



Impervite® multi-blox® cylindrical block heat exchangers

Product Overview

CG Thermal cylindrical block heat exchangers are designed and built for non-stop service: 24 hours a day, 365 days a year. These units are the smartest, sturdiest solution for your most demanding applications where down time or cross contamination is simply not an option.

The Multi-Blox units utilize a rugged, cylindrical graphite element low Slender ratio that eliminates the dangerous bending stresses found in other graphite heat exchanger designs. The units have excellent resistance to thermal shock, higher resistance to water/steam hammer and other mechanical abuses.

Our cylindrical units utilize some of the longest monolithic blocks available. These long blocks greatly reduce the number of required sealing gaskets and minimize the effects of "point loading" on the graphite. Point loading can and does lead to block cracking.

To increase the life and reliability of the unit during operation, our Multi-Blox® unit has some of the largest hole pitches in the industry. By spreading out the holes, we are able to increase the graphite rib between each hole up to three times more than industry standard offerings, lowering operational stresses that would crack other blocks and lead to failures. We can supply up to 1" (25.4mm) diameter process holes.

Features & Benefits

Key Points

- Rugged design for 24/7 operation and long service life
- Ideal for your most demanding application
- Excellent resistance to unexpected process upsets

- Maximum heat transfer area in minimum envelope size
- Process hole diameters of 0.375" (9.50mm), 0.50" (12.7mm), 0.750" (19mm) and 1.00" (25.4mm)
- Design pressure up to 150 psig (10.34 barg)
- Immunity to thermal shock throughout unit operating temperature range up to 350°F (175°C)
- Standardized longer blocks with fewer gaskets (less chance for leaks)
- Full mechanical and thermal guarantee
- All components 100% quality checked and hydro-tested
- High-reliability design for reduced operating and maintenance costs
- Vertical, horizontal or sloped mounting available
- Both process and service side of the unit can be supplied with a full ASME SEC VIII Div 1 code stamp



Scan QR Code
with your mobile
device for **Tech Specs**

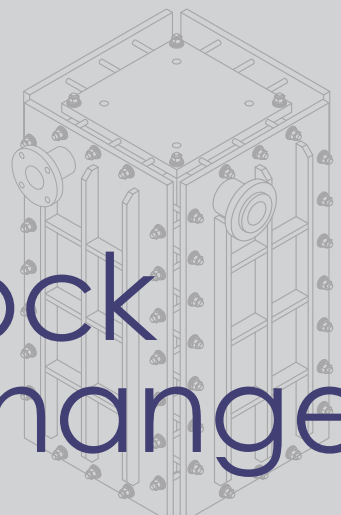
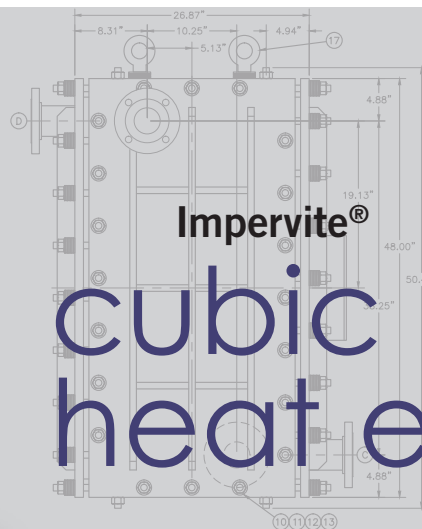

cubic block heat exchangers

Product Overview

Cubic heat exchangers offer the maximum heat transfer area in the smallest envelope size, typically resulting in lower capital investment costs. Both the process and service sides can be fitted with highly corrosion resistant Impervite®, making them the ideal choice as interchangers. In applications where high fouling is expected, easy access to both the process and service side holes make cleaning convenient and simple.

CG Thermal Impervite® cubic block heat exchangers offer many of the same features as our heavy duty cylindrical block heat exchangers and are fabricated using the same high quality impervious graphite, but typically at a lower investment cost. Our cubic design is your first choice for low pressure condenser service or when there is a corrosive fluid on both sides of the unit. Also, the true counter-current flow pattern is ideal for applications that require low temperature approaches or temperature cross.

Features & Benefits

- Heat transfer area range of 20 ft² (1.9m²) to 650 ft² (61m²)
- Maximum heat transfer area in minimum envelope size
- High thermal efficiency, even with low temperature approach and temperature cross
- Process hole diameters of 0.375" (9.50mm), 0.50" (12.7mm), and 0.750" (19mm)
- Design pressure up to 75 psig (5.17 barg)
- Single piece, monolithic Impervite® cubic element
- Full mechanical and thermal guarantee
- All components 100% quality checked and hydro-tested
- All the metal components can be supplied with a full ASME SEC VIII Div 1 code stamp
- Design allows easy access to both the service and process side of the unit, making them easy to clean and maintain



Scan QR Code with your mobile device for **Tech Specs**

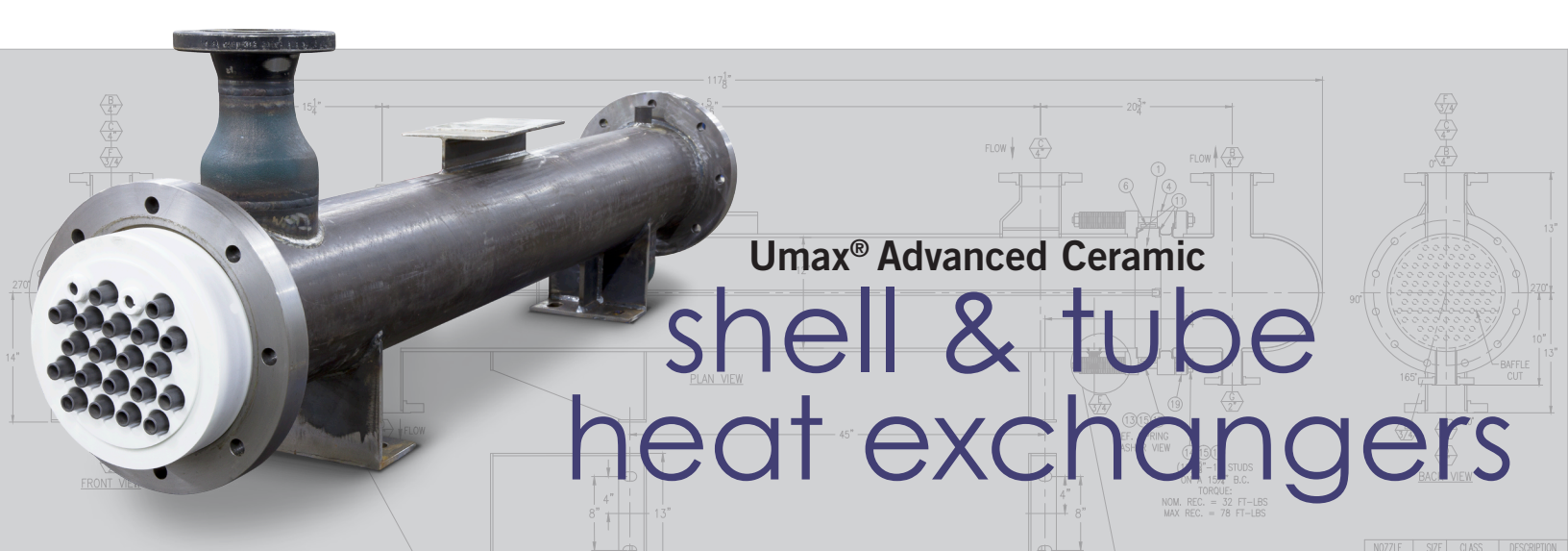

Umax[®] Advanced Ceramic shell & tube heat exchangers

Product Overview

Umax[®] ceramic heat exchangers: CG Thermal's Umax advanced ceramic shell and tube heat exchanger is extremely erosion and corrosion resistant - unmatched by any other material commonly found in the market place. It is practically a universal heat exchanger for corrosive fluids, and is guaranteed against erosion or corrosion for a period of two-years! **CG Thermal's Principal Design Engineer invented this technology, which won the 1988 Research and Development Magazine's R&D 100 award, and that same year won Chemical Processing's award as a major contribution toward more efficient and effective Plant Operations.**

Key Points

- Erosion and corrosion proof
- High thermal conductivity
- State-of-the-art user friendly design



Scan QR Code
with your mobile
device for **Tech Specs**

For Your Most Demanding Chemical Processes

Umax[®] advanced ceramic is the most universally corrosion and erosion-resistant material in the chemical processing industry. This brand of alpha sintered silicon carbide is an advanced ceramic that handles your corrosive chemicals - including mixed acids, hydrofluoric acid, free halogens, caustics and all other chemicals typically found in the industry's most reducing and oxidizing environments.

Its extreme hardness, high theoretical density, excellent strength properties and absence of free silicon make Umax[®] advanced ceramic inherently corrosion and erosion-proof. Umax[®] advanced ceramic is your universal value-added replacement for expensive reactive metals, nickel-alloys, not-so-conductive Teflon, and brittle glass and graphite.

Umax[®]'s unique properties are not achieved using impregnations (as in graphite) or reactive layers (as in reactive metals). Instead, Umax[®] is a homogeneous, extremely inert material. Umax[®] advanced ceramic is a sturdier alternative to reactive metals and nickel alloys which are prone to pin hole leaks and stress crack corrosion. It will maintain its original tube surface structure throughout its operating life, lowering the fouling rate in most chemical processes. It can also be cleaned with high pressure fluids with no danger of tube damage.

Unlike other ceramics and graphites used in the CPI market, Umax[®] is truly 100% resistant to thermal shock throughout its operating range. This is due to its high thermal conductivity, low thermal expansion rate, and high flexural and tensile strength properties.

Features & Benefits

- Our Umax[®] tubes are superior in that they are warranted against the failures typically found in the other materials
- Umax[®] tubing has exceptional high strength, hardness and thermal conductivity
- Easily maintained if required
- Each tube is independently tested to over 2,000 psig
- Unconditional two-year guarantee against corrosion and erosion on Umax[®] tubing

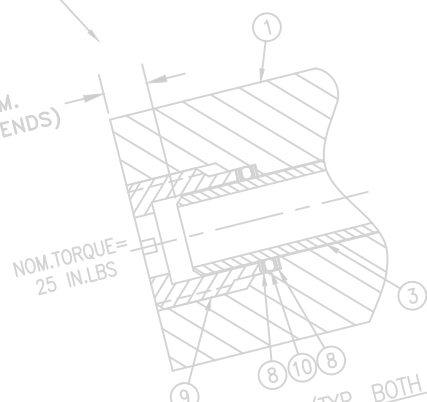
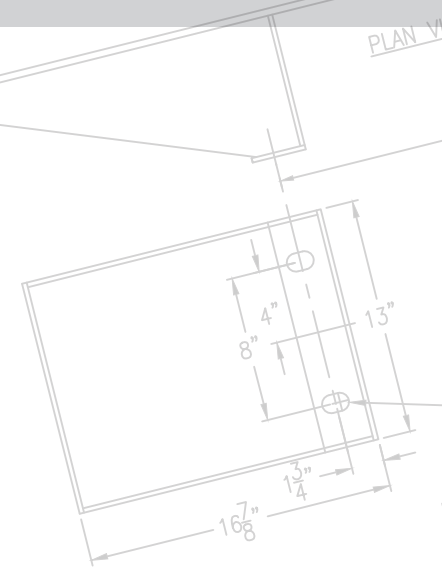
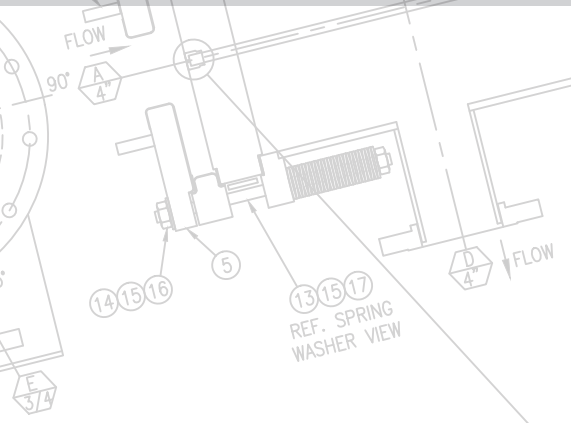
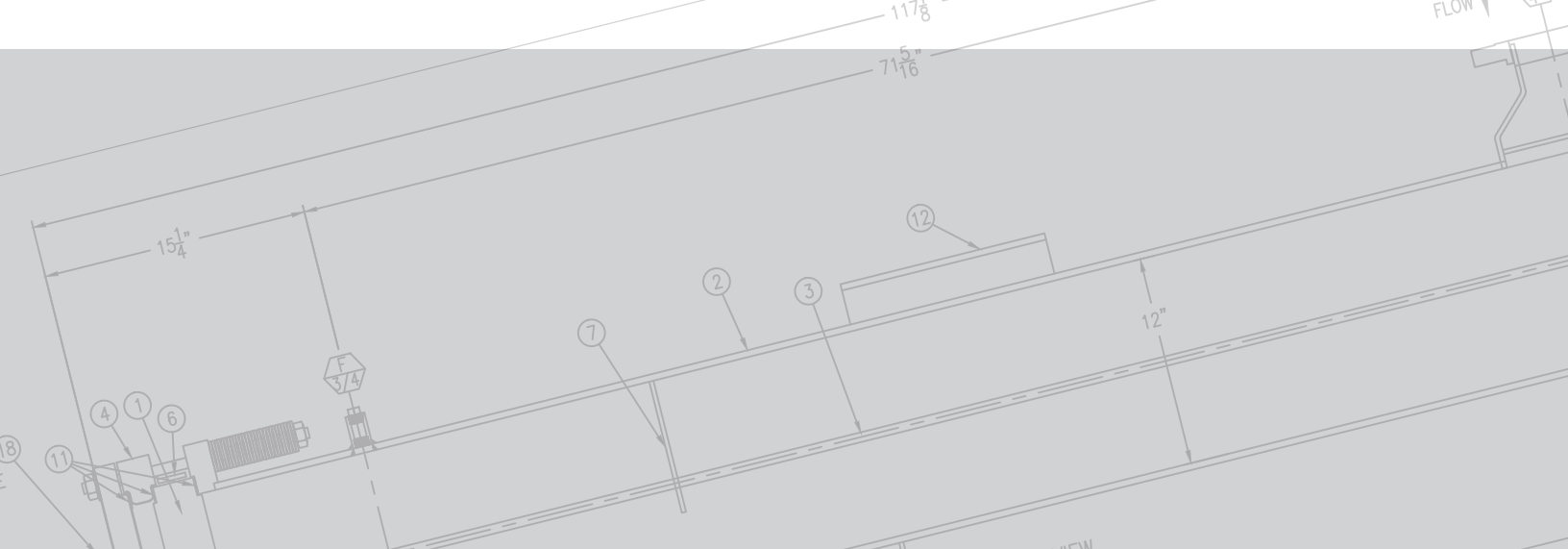

CGThermal LLC		PRESS. (PSID) TEMP. (°F)	
MAWP	100	340	
MAEWP	15	340	
MDMT	100	-20	
S/N	2061		
YEAR	2012		

CERTIFIED AND MANUFACTURED BY			
CGThermal			
PROCESS EQUIPMENT			
MAX. WORKING PRESS. (PSI)	100/FV	100/FV	SERVICE
MAX. WORKING TEMP. (°F)	340	340	100/FV
HYDRO. TEST PRESS. (PSI)	130	130	130
SERIAL NO.	2061	DRAWING NO.	H12-0104
ORDER NO.	MA0TH012	YEAR	2012
HD14-12-96 BEM			

CG THERMAL, LLC

8950 Dutton Dr.
Twinsburg, Ohio
USA 44087
P. 330-405-0844
F. 330-487-0304

www.CGThermal.com

USA Owned & Operated

PART No.	MATERIAL	DESCRIPTION
2-14-0101-TC	TUBESHEET	TUBESHEET
H12-0104-TC	SHELL SUB-ASSEMBLY	SHELL SUB-ASSEMBLY
H12-0104-S	TUBES - 14mmOD X 96"LG	TUBES - 14mmOD X 96"LG
H12-0104-BA	BOLTING RING	BOLTING RING
H12-0104-TC	CLAMP PLATE	CLAMP PLATE
H12-0104-BA	TUBESHEET COVER	TUBESHEET COVER
H-14-0101-TN	BAFFLE CAGE SUB-ASSEMBLY	BAFFLE CAGE SUB-ASSEMBLY
H12-STD-GSK	BACK-UP RING	BACK-UP RING
H12-0104-TC	TUBE NUT	TUBE NUT
H12-0104-TC	GASKET	GASKET
H12-0104-TC	NAME PLATE/BACKET	NAME PLATE/BACKET
H12-0104-TC	STUD, 5/8"-11 X 9.75" LG	STUD, 5/8"-11 X 9.75" LG
H12-0104-TC	STUD, 5/8"-11 X 3.00" LG	STUD, 5/8"-11 X 3.00" LG
H12-0104-TC	STUD, 5/8"-11 X 3.00" LG	STUD, 5/8"-11 X 3.00" LG
H12-0104-TC	STUD, 5/8"-11 X 3.00" LG	STUD, 5/8"-11 X 3.00" LG



- NOTES:
1. ALL NOZZLE BOLTS TO STRADDLE CENTERLINES.
 2. APPLY ANTI-RUST/SIEZE PER CGTHERMAL "U-ARUST-01".
 3. DUE TO SPECIAL NATURE OF UMUX CONSTRUCTION, HYDRO-TESTING WILL BE DONE AFTER PAINTING. 10 MIL PFA COATING TO BE APPLIED IN LIEU OF PAINT ON CLAMP PLATES & BOLTING RINGS.
 4. PROVIDE WASHERS UNDER ALL NUTS AT CLAMP PLATE STUDS ONLY.
 5. PAINT PER CG THERMAL STD: U-PAINT-07

NOTICE: THE UMUX ADVANCED CERAMIC EQUIPMENT SUPPLIED ON THIS ORDER IS THOROUGHLY INSPECTED & TESTED AT THE FACTORY PRIOR TO SHIPMENT AND IS ADEQUATELY INSULATED & BOXED TO PREVENT DAMAGE DUE TO NORMAL HANDLING DURING TRANSIT. UMUX ADVANCED CERAMIC IS FRAGILE & CG THERMAL LLC WARRANTY PROVISIONS REQUIRE THIS SHIPMENT TO BE INSPECTED & TESTED IMMEDIATELY UPON RECEIPT FOR CONCEALED HANDLING & SHIPPING DAMAGE.

2	NOZZLE C WAS 15.88 FROM CL. SADDLES REVISED AND RELOCATED	NAB	4/25/12
1		SWH	4/13/12
NO.		BY	DATE